



SSE Retail

# SB-20

ASEGURA TODOS LOS  
DISPOSITIVOS EN LA TIENDA



[www.sseretail.com.mx](http://www.sseretail.com.mx)

# CARACTERÍSTICAS

SB-20

Soporte de seguridad independiente compacto y versátil para todos los productos de visualización



**Estabilidad mejorada**  
para tabletas y cámaras



**Proyección frontal**  
Altavoces de alarma



**Cerradura de bayoneta**  
Para una fácil comercialización



**Función de bloqueo**  
Para teléfonos y tabletas



# CARACTERÍSTICAS

SB-20

Soporte de seguridad independiente compacto y versátil para todos los productos de visualización



**Puerto protegido doble**



**Lector de llaves rediseñado**  
Con alta sensibilidad



**Numerosos sensores**  
Y accesorios



**Accesorios premium**  
Para grandes marcas



# COMPONENTES

TELÉFONOS Y TABLET

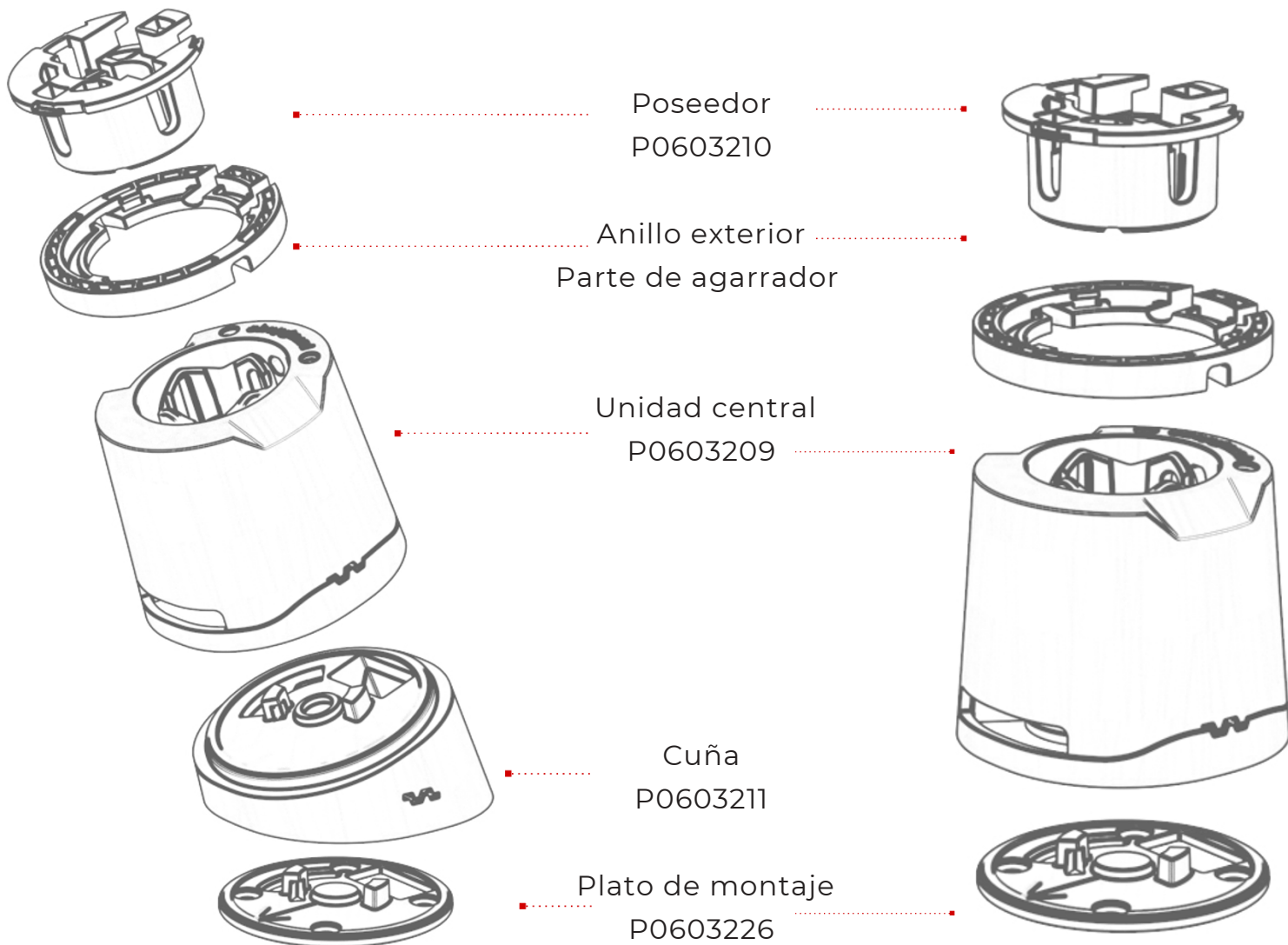



No se mostro:  
PSU, cargadores,  
adhesivos(ver las  
siguientes páginas)



# KITS

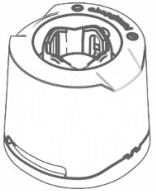

## TELÉFONO Y TABLET

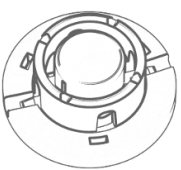
### Teléfono y tablet kit - P0601614

Imagen	Parte #	Descripción
	P0603209	SB-20 Stand, White
	P0603211	SB-20 cuña, blanca
	P0603210	SB-20 poseedor

\*No incluye: cables (siguiente página), PSU.

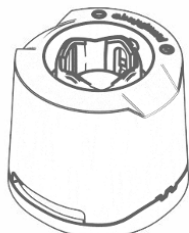
### COB (Objetos conectados) kit-P0601617

Imagen	Parte #	Descripción
	P0603209	SB-20 Soporte, blanco
	P0603218	SB-20 Cubierta superior



# COMPONENTES

## ACCESORIOS

Cubierta superior  
P0603218





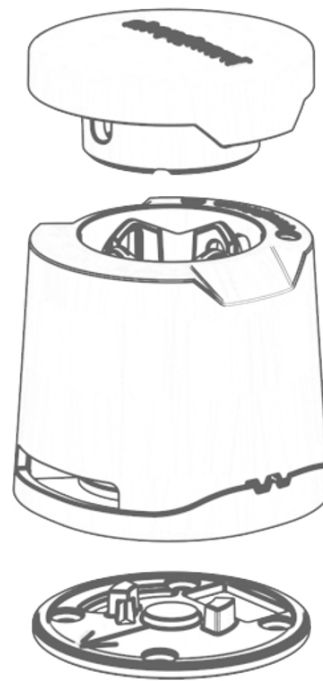



Unidad central  
P0603209

Plato montador  
P0603226

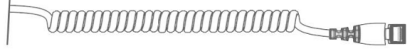

\*No se mostró: PSU,  
sensores, adhesivos (ver  
siguientes páginas)

### Cables y sensores I.

Imagen	Part #	Descripción
 	P0603207	Cable de carga - Apple Lightning, blanco
 	P0603213	Cable de carga - micro USB, blanco
 	P0603214	Cable de carga: USB tipo C, blanco
 	P0603215	COB sensor, blanco
	P0601598	Apple watch sensor + cable clip







## PSUs

Parte #	Descripción
P0603106	PSUUSB-A5.2V/2A -EUplug
P0603195	PSUUSB-A5.2V/2A -AUSplug
P0603194	PSUUSB-A5.2V/2A -UKplug
P0603193	PSUUSB-A5.2V/2A -USplug
P0601600	USB-Apower splitter for Apple OEM watch

## Adhesivos y toallitas

Parte #	Descripción
P0620123	SB-20 adhesivo de soporte pequeño (para teléfonos)
P0620122	SB-20 adhesivo de soporte (para tabletas)
P0620121	SB-20 adhesivo para placa de montaje
P0620096	COBadhesivo del sensor
P0620096	Adhesivo del sensor secundario de la lente de la cámara
P0620119	Adhesivo para sensor de Apple Watch
P0620126	Adhesivo para sensor DSLR
P0601563	Toallita con alcohol

## Llaves y herramientas

Imagen	Parte #	Descripción
	P0601593	M2 llave Allen (lock-down tool)
	P0603019	Llave Wave bloqueo de la unidad principal a la cuña / placa de montaje)
	P0600413	Abridor de sensor de camera
	P0600286	¡Button ON / OF Black



# DATOS TÉCNICOS

CROB

Base de montar

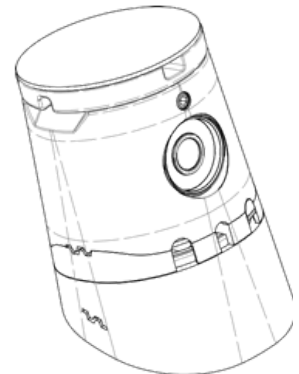
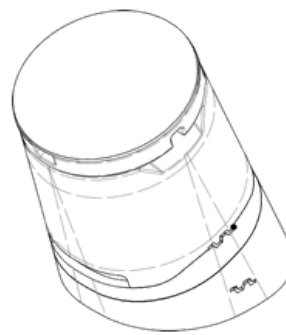
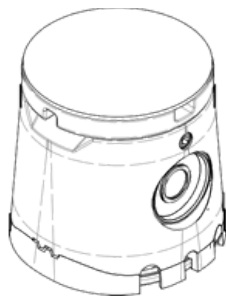
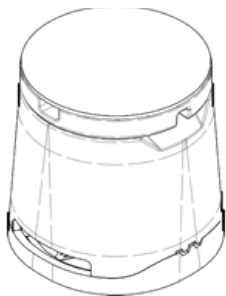
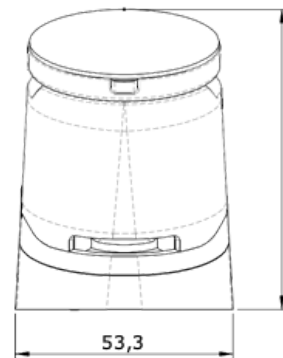
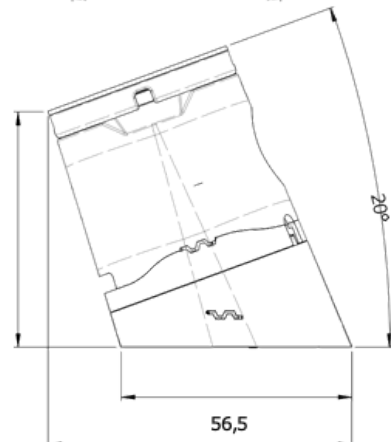
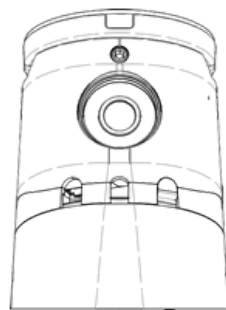
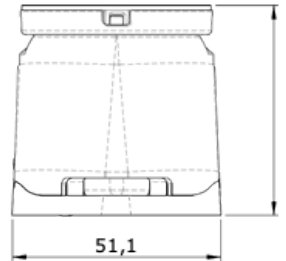
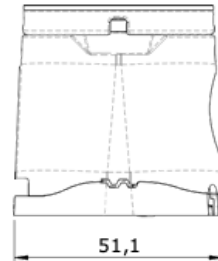
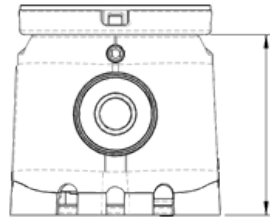
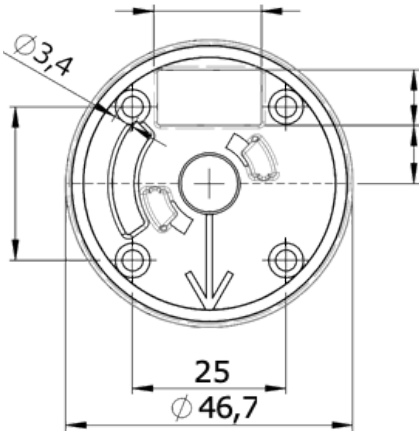

## Tipo de producto:

Producto de pie

## Colores disponibles:

Blanco, preguntar por otro color

## Opciones de montaje

Base de montaje con adhesivos  
Agujeros para tornillos autorroscantes

## Entrada

110-240 VAC, 50-60Hz  
0.3A

## Salida/ Ccompatibilidad de carga

5.2V =2A

## Batería

Batería tipo li ion con 120mA/3.7V - Batería de backup

## Tipo de producto

Nombre: Avisadores acústicos  
Código arancelario: 85311004

## Señalización de alarmado

Tono en Buzzer integrado  
Flasheo de luces led en rojo

## Monitoreo remoto

Vía software.

SSE Retail







## Contacto

Tel. Oficina: 442 161 0631 Ext. 180

Cel: 55 6543 1767

**Laura Pinto**

Cel. 55 6543 1767

[laura.pinto@sseretail.com.mx](mailto:laura.pinto@sseretail.com.mx)

[www.sseretail.com.mx](http://www.sseretail.com.mx)

Sendero de Granada 2, Milenio 3ra Sección,  
Oficina 22, 76060 Santiago de Querétaro, Querétaro  
México

Soluciones de Seguridad Electrónica para el Retail  
en Latam S.A. de C.V.

**SSE Retail**